

33-0010-R5

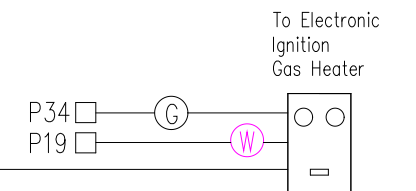
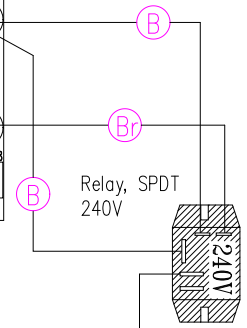
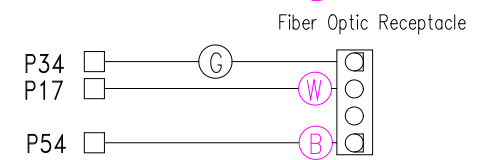
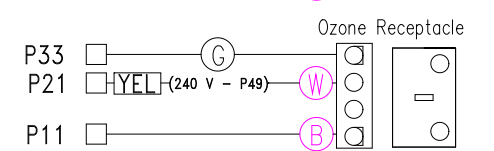
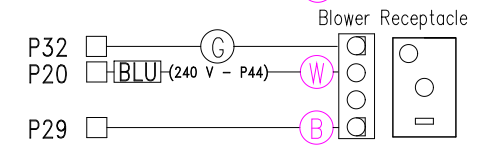
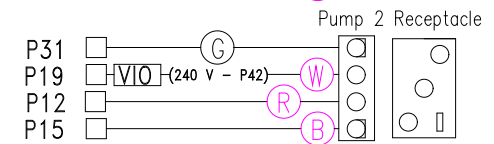
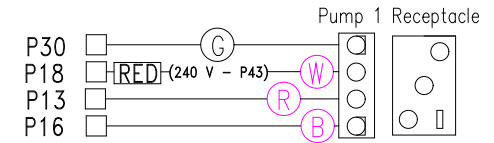
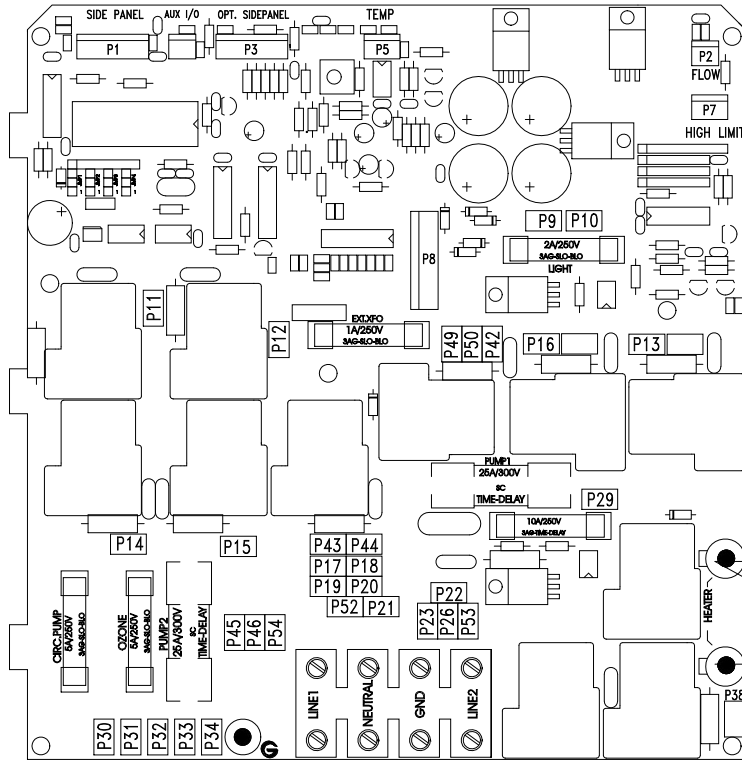
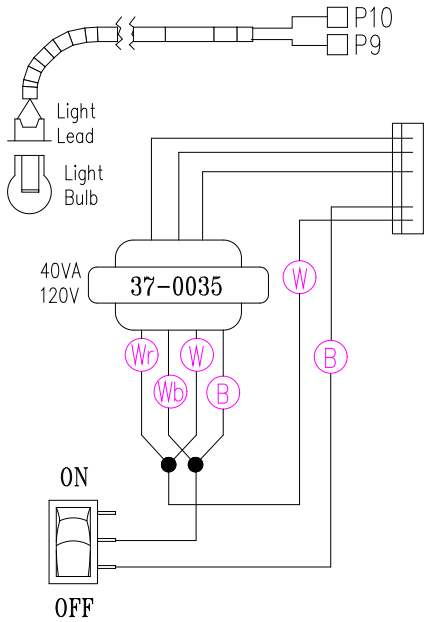
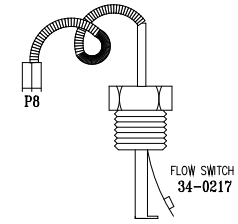

LEGEND	
	- 1/4" QUICK CONNECT
	- 1/4" QUICK CONNECT PIGGYBACK
	- FORK CONNECTOR
	- RING CONNECTOR
	- SOCKET CONNECTOR
	- PIN CONNECTOR

HYDRO-QUIP
CORONA, CA (909) 273-7575

Manufacture Notes:

Approved By:

Dwg. No.
GC222A0-KPQY8

Drawn
DJT
Date
6.5.01
Diagram No.
5007

Wire Color Code	
B - Black	G - Green
Br - Brown	Bl - Blue
R - Red	V - Violet
O - Orange	W - White
Y - Yellow	Gr - Gray

SHADED COMPONENTS ARE 240V